

SONY®

4-410-140-11(1)

Blu-ray Disc™ / DVD Player

Operating Instructions

Getting Started

Playback

Internet

Settings and Adjustments

Additional Information



BDP-S590/BX59

WARNING

To reduce the risk of fire or electric shock, do not expose this apparatus to rain or moisture.

To avoid electrical shock, do not open the cabinet. Refer servicing to qualified personnel only.

The AC power cord must be changed only at a qualified service shop.

Batteries or batteries installed apparatus shall not be exposed to excessive heat such as sunshine, fire or the like.

CAUTION

The use of optical instruments with this product will increase eye hazard. As the laser beam used in this Blu-ray Disc/DVD player is harmful to eyes, do not attempt to disassemble the cabinet. Refer servicing to qualified personnel only.

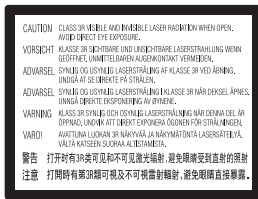

This label is located on the laser protective housing inside the enclosure.



This symbol is intended to alert the user to the presence of uninsulated “dangerous voltage” within the product’s enclosure that may be of sufficient magnitude to constitute a risk of electric shock to persons.



This symbol is intended to alert the user to the presence of important operating and maintenance (servicing) instructions in the literature accompanying the appliance.

Precautions

- To prevent fire or shock hazard, do not place objects filled with liquids, such as vases, on the apparatus.
- Install this unit so that the AC power cord can be unplugged from the wall socket immediately in the event of trouble.

Operation is subject to the following two conditions;
(1) this device may not cause interference, and
(2) this device must accept any interference received,
including interference that may cause undesired operation of the device.

FCC WARNING

You are cautioned that any changes or modifications not expressly approved in this manual could void your authority to operate this equipment.

This transmitter must not be co-located or operating in conjunction with any other antenna or transmitter.

The shielded Interface cable (LAN cable) must be used with the equipment in order to comply with the limits for a digital device pursuant to Subpart B of Part 15 of FCC Rules.



This equipment has been tested and found to comply with the limits for a Class B digital device, pursuant to Part 15 of the FCC Rules. These limits are designed to provide reasonable protection against harmful interference in a residential installation. This equipment generates, uses, and can radiate radio frequency energy and, if not installed and used in accordance with the instructions, may cause harmful interference to radio communications. However, there is no guarantee that interference will not occur in a particular installation. If this equipment does cause harmful interference to radio or

television reception, which can be determined by turning the equipment off and on, the user is encouraged to try to correct the interference by one or more of the following measures:

- Reorient or relocate the receiving antenna.
- Increase the separation between the equipment and receiver.
- Connect the equipment into an outlet on a circuit different from that to which the receiver is connected.
- Consult the dealer or an experienced radio/TV technician for help.

FCC Radiation Exposure Statement:

This equipment complies with FCC radiation exposure limits set forth for an uncontrolled environment and meets the FCC radio frequency (RF) Exposure Guidelines in Supplement C to OET65. This equipment should be installed and operated keeping the radiator at least 20cm or more away from person's body (excluding extremities: hands, wrists, feet and ankles).

IC Radiation Exposure Statement:

This equipment complies with IC radiation exposure limits set forth for an uncontrolled environment and meets RSS-102 of the IC radio frequency (RF) Exposure rules. This equipment should be installed and operated keeping the radiator at least 20cm or more away from person's body (excluding extremities: hands, wrists, feet and ankles).

Contains FCC ID : EW4DWMW069

Contains IC : 4250A-DWMW069

This class B digital apparatus complies with Canadian ICES-003.

Important Safety Instructions

- 1) Read these instructions.
- 2) Keep these instructions.
- 3) Heed all warnings.
- 4) Follow all instructions.
- 5) Do not use this apparatus near water.
- 6) Clean only with dry cloth.
- 7) Do not block any ventilation openings. Install in accordance with the manufacturer's instructions.

- 8) Do not install near any heat sources such as radiators, heat registers, stoves, or other apparatus (including amplifiers) that produce heat.
- 9) Do not defeat the safety purpose of the polarized or grounding-type plug. A polarized plug has two blades with one wider than the other. A grounding type plug has two blades and a third grounding prong. The wide blade or the third prong are provided for your safety. If the provided plug does not fit into your outlet, consult an electrician for replacement of the obsolete outlet.
- 10) Protect the power cord from being walked on or pinched particularly at plugs, convenience receptacles, and the point where they exit from the apparatus.
- 11) Only use attachments/accessories specified by the manufacturer.
- 12) Use only with the cart, stand, tripod, bracket, or table specified by the manufacturer, or sold with the apparatus. When a cart is used, use caution when moving the cart/apparatus combination to avoid injury from tip-over.



- 13) Unplug this apparatus during lightning storms or when unused for long periods of time.
- 14) Refer all servicing to qualified service personnel. Servicing is required when the apparatus has been damaged in any way, such as power-supply cord or plug is damaged, liquid has been spilled or objects have fallen into the apparatus, the apparatus has been exposed to rain or moisture, does not operate normally, or has been dropped.

Owner's Record

The model and serial numbers are located at the rear of the unit. Record the serial number in the space provided below. Refer to them whenever you call upon your Sony dealer regarding this product.

Model No. _____

Serial No. _____

For customers in the USA

If this product is not working properly, please call 1-866-909-7669.

For Customers in Canada

If this product is not working properly, please contact our **Customer Information Service Center** at 1-877-899-7669 or write to us at: Customer Information Service 115 Gordon Baker Road, Toronto, Ontario, M2H 3R6

Precautions

This equipment has been tested and found to comply with the limits set out in the EMC Directive using a connection cable shorter than 3 metres.

On placement

- Place the player in a location with adequate ventilation to prevent heat build-up in the player.
- Do not place the player on a soft surface such as a rug that might block the ventilation holes.
- Do not install this player in a confined space, such as a bookshelf or similar unit.
- Do not place the player in a location near heat sources, or in a place subject to direct sunlight, excessive dust, or mechanical shock.
- Do not place the player outdoors, in vehicles, on ships, or on other vessels.
- If the player is brought directly from a cold to a warm location, or is placed in a very damp room, moisture may condense on the lenses inside the player. Should this occur, the player may not operate properly. In this case, remove the disc and leave the player turned on for about half an hour until the moisture evaporates.
- Do not install the player in an inclined position. It is designed to be operated in a horizontal position only.
- Do not place metal objects in front of the front panel. It may limit reception of radio waves.
- Do not place the player in a place where medical equipment is in use. It may cause a malfunction of medical instruments.
- If you use a pacemaker or other medical device, consult your physician or the

manufacturer of your medical device before using the wireless LAN function.

- Do not place heavy or unstable objects on the player.
- Do not place any objects other than discs on the disc tray. Doing so may cause damage to the player or the object.
- Take out any discs from the tray when you move the player. If you don't, the disc may be damaged.
- Disconnect the AC power cord and all other cables from the player when you move the player.

On power sources

- The player is not disconnected from the AC power source as long as it is connected to the wall outlet, even if the player itself has been turned off.
- Disconnect the player from the wall outlet if you are not going to use the player for a long time. To disconnect the AC power cord, grasp the plug itself; never pull the cord.
- Observe following points to prevent the AC power cord being damaged. Do not use the AC power cord if it is damaged, as doing so may result in an electric shock or fire.
 - Do not pinch the AC power cord between the player and wall, shelf, etc.
 - Do not put anything heavy on the AC power cord or pull on the AC power cord itself.

On adjusting volume

Do not turn up the volume while listening to a section with very low level inputs or no audio signals. Your ears and the speakers may be damaged when the sound level reaches the peak.

On cleaning

Clean the cabinet, panel, and controls with a soft cloth. Do not use any type of abrasive pad, scouring powder or solvent such as alcohol or benzine.

On cleaning discs, disc/lens cleaners

Do not use cleaning discs or disc/lens cleaners (including wet or spray types). These may cause the apparatus to malfunction.

On replacement of parts

In the events that this player is repaired, repaired parts may be collected for reuse or recycling purposes.

On connecting to the HDMI OUT jack

Observe the following as improper handling may damage the HDMI OUT jack and the connector.

- Carefully align the HDMI OUT jack on the rear of the player and the HDMI connector by checking their shapes. Make sure the connector is not upside down or tilted.

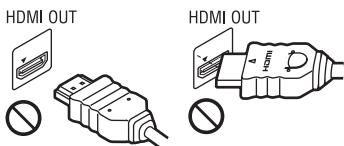

- Be sure to disconnect the HDMI cable when moving the player.



- Hold the HDMI connector straight when connecting or disconnecting the HDMI cable. Do not twist or force the HDMI connector into the HDMI OUT jack.

On watching 3D video images

Some people may experience discomfort (such as eye strain, fatigue, or nausea) while watching 3D video images. Sony recommends that all viewers take regular breaks while watching 3D video images. The length and frequency of necessary breaks will vary from person to person. You must decide what works best. If you experience any discomfort, you should stop watching the 3D video images until the discomfort ends; consult a doctor if you believe necessary. You should also review (i) the instruction manual and/or the caution message of any other device used with, or Blu-ray Disc contents played with this product and (ii) our website (<http://esupport.sony.com/>) for the latest

information. The vision of young children (especially those under six years old) is still under development. Consult your doctor (such as a pediatrician or eye doctor) before allowing young children to watch 3D video images.

Adults should supervise young children to ensure they follow the recommendations listed above.

IMPORTANT NOTICE

Caution: This player is capable of holding a still video image or on-screen display image indefinitely. If you leave the still video image or on-screen display image displayed on your TV for an extended period of time you risk permanent damage to your television screen. Plasma display panel televisions and projection televisions are susceptible to this.

If you have any questions or problems concerning your player, please consult your nearest Sony dealer.

Copy Protection

Please be advised of the advanced content protection systems used in both Blu-ray Disc™ and DVD media. These systems, called AACS (Advanced Access Content System) and CSS (Content Scramble System), may contain some restrictions on playback, analog output, and other similar features. The operation of this product and the restrictions placed may vary depending on the date of purchase, as the governing board of the AACS may adopt or change its restriction rules after the time of purchase.

Copyrights and Trademarks

- “AVCHD” and the “AVCHD 3D/ Progressive” logo are trademarks of Panasonic Corporation and Sony Corporation.
- Java is a trademark of Oracle and/or its affiliates.

- “XMB,” and “cross media bar” are trademarks of Sony Corporation and Sony Computer Entertainment Inc.
- This product incorporates High-Definition Multimedia Interface (HDMI[®]) technology. HDMI, the HDMI logo and High-Definition Multimedia Interface are trademarks or registered trademarks of HDMI Licensing LLC in the United States and other countries.
- Blu-ray Disc[™], Blu-Ray[™], Blu-Ray 3D[™], BD-Live[™], BONUSVIEW[™], and the logos are trademarks of the Blu-ray Disc Association.
- “DVD+RW,” “DVD-RW,” “DVD+R,” “DVD-R,” “DVD VIDEO,” and “CD” logos are trademarks.
- “x.v.Color” and “x.v.Color” logo are trademarks of Sony Corporation.
- “BRAVIA” is a trademark of Sony Corporation.
- “PhotoTV HD” and the “PhotoTV HD” logo are trademarks of Sony Corporation.
- MPEG Layer-3 audio coding technology and patents licensed from Fraunhofer IIS and Thomson.
- Windows Media is either a registered trademark or trademark of Microsoft Corporation in the United States and/or other countries.

This product contains technology subject to certain intellectual property rights of Microsoft. Use or distribution of this technology outside of this product is prohibited without the appropriate license(s) from Microsoft.

Content owners use Microsoft PlayReady[™] content access technology to protect their intellectual property, including copyrighted content. This device uses PlayReady technology to access PlayReady-protected content and/or WDRM-protected content. If the device fails to properly enforce restrictions on content usage, content owners may require Microsoft to revoke the device’s ability to consume PlayReady-protected content. Revocation should not affect unprotected content or content protected by other content access technologies. Content owners may require

you to upgrade PlayReady to access their content. If you decline an upgrade, you will not be able to access content that requires the upgrade.

- This product meets ENERGY STAR[®] guidelines for energy efficiency. ENERGY STAR and the ENERGY STAR mark are registered U.S. marks. ENERGY STAR is a registered mark owned by the U.S. government.
- Music and video recognition technology and related data are provided by Gracenote[®]. Gracenote is the industry standard in music recognition technology and related content delivery. For more information, please visit www.gracenote.com. CD, DVD, Blu-ray Disc, and music and video-related data from Gracenote, Inc., copyright © 2000-present Gracenote. Gracenote Software, copyright © 2000-present Gracenote. One or more patents owned by Gracenote apply to this product and service. See the Gracenote website for a nonexhaustive list of applicable Gracenote patents. Gracenote, CDDb, MusicID, MediaVOCS, the Gracenote logo and logotype, and the “Powered by Gracenote” logo are either registered trademarks or trademarks of Gracenote in the United States and/or other countries.



- Wi-Fi[®], Wi-Fi Protected Access[®] and Wi-Fi Alliance[®] are registered marks of the Wi-Fi Alliance.
- Wi-Fi CERTIFIED[™], WPA[™], WPA2[™] and Wi-Fi Protected Setup[™] are marks of the Wi-Fi Alliance.
- The Wi-Fi CERTIFIED Logo is a certification mark of the Wi-Fi Alliance.
- The Wi-Fi Protected Setup Mark is a mark of the Wi-Fi Alliance.
- DLNA[®], the DLNA Logo and DLNA CERTIFIED[™] are trademarks, service marks, or certification marks of the Digital Living Network Alliance.

- Opera® Browser from Opera Software ASA. Copyright 1995-2010 Opera Software ASA. All rights reserved.



- All other trademarks are trademarks of their respective owners.
- Other system and product names are generally trademarks or registered trademarks of the manufacturers.™ and ® marks are not indicated in this document.

Gracenote® End User License Agreement

Version 20061005

This application or device contains software from Gracenote, Inc. of Emeryville, California (“Gracenote”). The software from Gracenote (the “Gracenote Software”) enables this application to perform disc and/or file identification and obtain music-related information, including name, artist, track, and title information (“Gracenote Data”) from online servers or embedded databases (collectively, “Gracenote Servers”) and to perform other functions. You may use Gracenote Data only by means of the intended End-User functions of this application or device.

You agree that you will use Gracenote Data, the Gracenote Software, and Gracenote Servers for your own personal non-commercial use only. You agree not to assign, copy, transfer or transmit the Gracenote Software or any Gracenote Data to any third party. **YOU AGREE NOT TO USE OR EXPLOIT GRACENOTE DATA, THE GRACENOTE SOFTWARE, OR GRACENOTE SERVERS, EXCEPT AS EXPRESSLY PERMITTED HEREIN.**

You agree that your non-exclusive license to use the Gracenote Data, the Gracenote Software, and Gracenote Servers will terminate if you violate these restrictions. If your license terminates, you agree to cease any and all use of the Gracenote Data, the Gracenote Software, and Gracenote Servers. Gracenote reserves all rights in Gracenote Data, the Gracenote Software, and the Gracenote Servers, including all ownership rights. Under no circumstances will Gracenote become liable for any payment to you for any information that you provide. You agree that Gracenote, Inc. may enforce its rights under this Agreement against you directly in its own name.

The Gracenote service uses a unique identifier to track queries for statistical purposes. The purpose of a randomly assigned numeric identifier is to allow the Gracenote service to count queries without knowing anything about who you are. For more information, see the web page for the Gracenote Privacy Policy for the Gracenote service.

The Gracenote Software and each item of Gracenote Data are licensed to you “AS IS.” Gracenote makes no representations or warranties, express or implied, regarding the accuracy of any Gracenote Data from in the Gracenote Servers. Gracenote reserves the right to delete data from the Gracenote Servers or to change data categories for any cause that Gracenote deems sufficient. No warranty is made that the Gracenote Software or Gracenote Servers are error-free or that functioning of Gracenote Software or Gracenote Servers will be uninterrupted. Gracenote is not obligated to provide you with new enhanced or additional data types or categories that Gracenote may provide in the future and is free to discontinue its services at any time.

GRACENOTE DISCLAIMS ALL WARRANTIES EXPRESS OR IMPLIED, INCLUDING, BUT NOT LIMITED TO, IMPLIED WARRANTIES OF MERCHANTABILITY, FITNESS FOR A PARTICULAR PURPOSE, TITLE, AND NON-INFRINGEMENT. GRACENOTE DOES NOT WARRANT THE RESULTS THAT WILL BE OBTAINED BY YOUR USE OF THE GRACENOTE SOFTWARE OR ANY GRACENOTE SERVER. IN NO CASE WILL GRACENOTE BE LIABLE FOR ANY CONSEQUENTIAL OR INCIDENTAL DAMAGES OR FOR ANY LOST PROFITS OR LOST REVENUES.

© Gracernote 2006

Table of Contents

WARNING	2
Precautions	4

Getting Started

Guide to Parts and Controls	10
Step 1: Supplied Accessories	14
Step 2: Connecting the Player	15
Step 3: Preparing for Network Connection	18
Step 4: Easy Setup	18

Playback

Playing a Disc	20
Playing from a USB Device	21
Playing via a Network	22
Available Options	24

Internet

Browsing Websites	26
-------------------------	----

Settings and Adjustments

Using the Settings Displays	28
[Network Update]	28
[Screen Settings]	28
[Audio Settings]	29
[BD/DVD Viewing Settings]	30
[Parental Control Settings]	31
[Music Settings]	31
[System Settings]	31
[Network Settings]	32
[Easy Setup]	33
[Resetting]	33

Additional Information

Troubleshooting	34
Specifications	38

Guide to Parts and Controls

Front panel

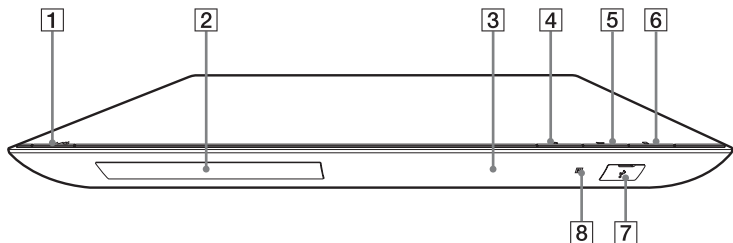

The ► button has a tactile dot. Use the tactile dot as a reference when operating the player.

1 I/O (on/standby)

Turns on the player, or sets to standby mode.

2 Disc tray

3 Front panel display

4 ▲ (open/close)

5 ► (play)

6 ■ (stop)

7 USB jack

Connect a USB device to this jack.

8 Remote sensor

To lock the disc tray (Child Lock)

You can lock the disc tray to avoid accidental opening of the tray.

While the player is turned on, hold down the ► button on the player for more than 10 seconds to lock or unlock the tray.

Rear panel

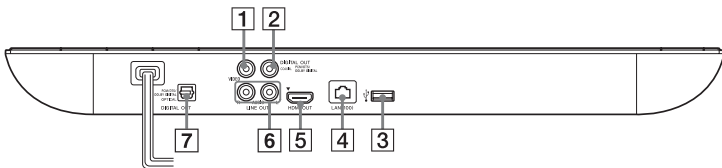

- | | |
|-------------------------------------|-------------------------------------|
| 1 LINE OUT (VIDEO) jack | 5 HDMI OUT jack |
| 2 DIGITAL OUT (COAXIAL) jack | 6 LINE OUT (R-AUDIO-L) jacks |
| 3 USB jack | 7 DIGITAL OUT (OPTICAL) jack |
| 4 LAN (100) terminal | |

Remote

The available functions of the remote are different depending on the disc or the situation.

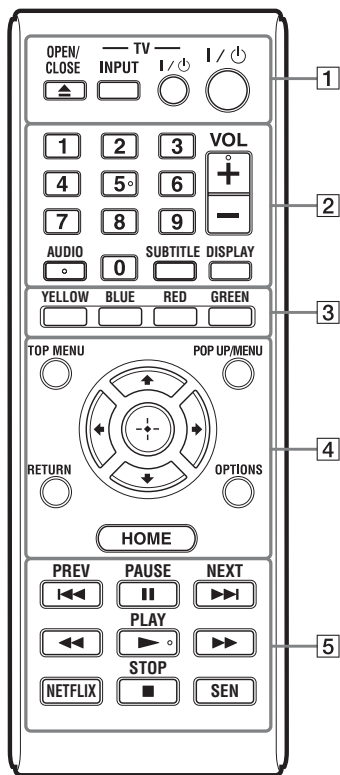

Number 5, AUDIO, VOL +, and ► PLAY buttons have a tactile dot. Use the tactile dot as a reference when operating the player.

The player automatically returns to standby mode

If any button on the player or remote is not pressed for more than 30 minutes, the player automatically returns to standby mode.

1 ▲ OPEN/CLOSE

Opens or closes the disc tray.

-TV- INPUT

Switches between TV and other input sources.

-TV- I/⏻ (on/standby)

Turns on the TV, or sets to standby mode.

I/⏻ (on/standby)

Turns on the player, or sets to standby mode.

2 Number buttons (0 - 9)

Enters the title/chapter numbers, etc.

VOL +/-

Adjusts the TV volume.

AUDIO (page 30)

Selects the language track when multi-lingual tracks are recorded on BD-ROMs/DVD VIDEOS.
Selects the sound track on CDs.

SUBTITLE (page 30)

Selects the subtitle language when multi-lingual subtitles are recorded on BD-ROMs/DVD VIDEOS.

DISPLAY (page 21)

Displays the playback and web browsing information on the screen.

3 Color buttons (YELLOW/BLUE/RED/GREEN)

Shortcut keys for interactive functions.

4 TOP MENU

Opens or closes the BD's or DVD's Top Menu.

POP UP/MENU

Opens or closes the BD-ROM's Pop-up Menu, or the DVD's menu.

OPTIONS (page 24)

Displays the available options on the screen.

HOME

Enters the player's home menu. Displays the wall paper when pressed on the category icon of the home menu.

RETURN

Returns to the previous display.



Moves the highlight to select a displayed item.

Center button (ENTER)

Enters the selected item.

5 **◀◀ PREV/NEXT ▶▶**

Skips to the previous/next chapter, track, or file.

II PAUSE

Pauses or re-starts playback.

◀◀/▶▶ (fast reverse/fast forward)

- Fast reverse/fast forward the disc when you press the button during playback. The search speed changes each time you press the button during video playback.
- Plays in slow motion, when pressed for more than one second in pause mode.
- Plays one frame at a time, when you press for a short time in pause mode.



Playback in slow motion or one frame is not available for a Blu-ray 3D Disc.

▶ PLAY

Starts or re-starts playback.

NETFLIX

Enables access to the "NETFLIX" online service.

■ STOP

Stops playback and remembers the stop point (resume point). The resume point for a title/track is the last point you played or the last photo for a photo folder.

SEN (page 22)

Accesses the "Sony Entertainment Network™" online service.

Home menu display

The home menu appears when you press HOME. Select a category using ◀/▶. Select an item using ↑/↓, and press ENTER.

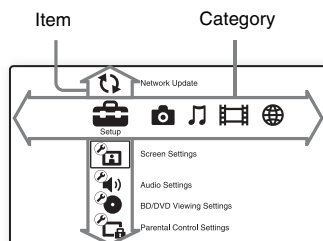

- [Setup]: Adjusts the player settings.
- [Photo]: Displays photos.
- [Music]: Plays music.
- [Video]: Plays videos.
- [Network]: Displays network items.

Step 1: Supplied Accessories

Check that you have the following items:

- Audio/video cable (phono plug ×3) (1)
- High Speed HDMI Cable (1)
(BDP-BX59 only)
- Remote commander (remote) (1)
- Size AA (R6) batteries (2)

Step 2: Connecting the Player







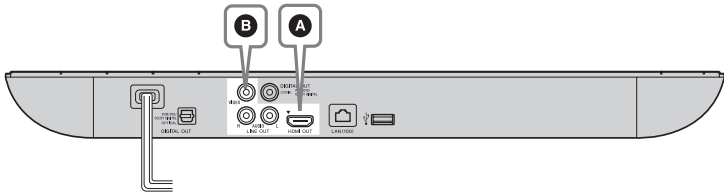

Do not connect the AC power cord until you have made all the connections.

Connecting to your TV

Select one of the following connection methods according to the input jacks on your TV.

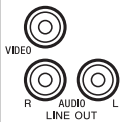
Match the color of the plug to that of the jack when connecting.

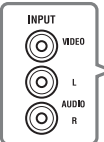

<p>A</p>  <p>HDMI OUT</p>	<p>High Speed HDMI Cable*</p> 	<p>High quality</p>   <p>HD</p>
<p>B</p>  <p>VIDEO R AUDIO L LINE OUT</p>	<p>Audio/video cable (supplied)</p> 	  <p>SD</p> <p>Standard quality</p>

* See “Step 1: Supplied Accessories” (page 14).



Do not connect the player through a VCR. Video signals from VCRs can be affected by copyright protection systems that cause the picture on the TV to be distorted.

Connecting to your AV amplifier (receiver)

Select one of the following connection methods according to the input jacks on your AV amplifier (receiver). When you select **A** or **B**, make the appropriate settings in the [Audio Settings] setup (page 29).

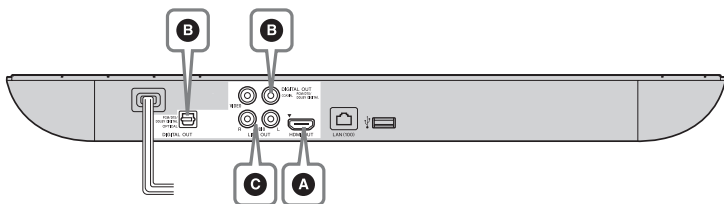

A

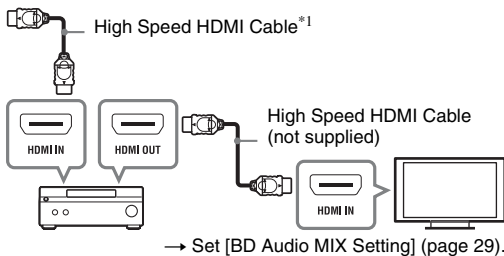

B

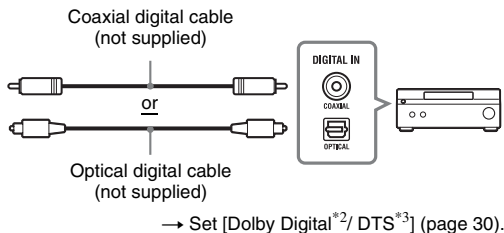

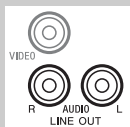
C

Audio/video cable (supplied)

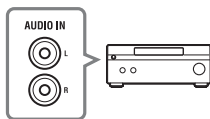

- *1 See “Step 1: Supplied Accessories” (page 14).
- *2 Manufactured under license from Dolby Laboratories. Dolby, Pro Logic, and the double-D symbol are trademarks of Dolby Laboratories.
- *3 Manufactured under license under U.S. Patent Nos: 5,956,674; 5,974,380; 6,226,616; 6,487,535; 7,212,872; 7,333,929; 7,392,195; 7,272,567 & other U.S. and worldwide patents issued & pending. DTS-HD, the Symbol, & DTS-HD and the Symbol together are registered trademarks & DTS-HD Master Audio is a trademark of DTS, Inc. Product includes software. © DTS, Inc. All Rights Reserved.

Step 3: Preparing for Network Connection

If you are not going to connect the player to a network, proceed to “Step 4: Easy Setup” (page 18).

Wired Setup

Use a LAN cable to connect to the LAN (100) terminal on the player.

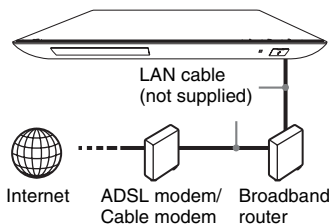

Using a shielded interface cable (LAN cable), straight or crossing, is recommended.

Wireless Setup

Use the wireless LAN that is built into the player.

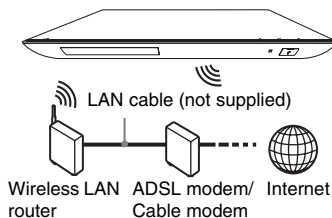

Step 4: Easy Setup

When turned on for the first time

Wait for a short while before the player turns on and starts [Easy Initial Settings].

- 1** Insert two Size AA (R6) batteries by matching the \oplus and \ominus ends on the batteries to the markings inside the battery compartment.

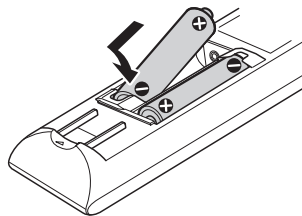

- 2** Plug the player into the AC outlet.

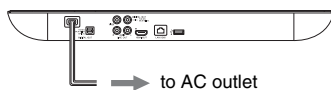

- 3** Press I/⏻ to turn on the player.

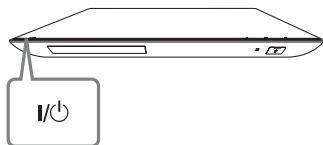

- 4** Turn on the TV and set the input selector on your TV. This will show the signal from the player on your TV screen.

5 Perform [Easy Initial Settings].

Follow the on-screen instructions to make the basic settings using ←/↑/↓/→ and ENTER on the remote.

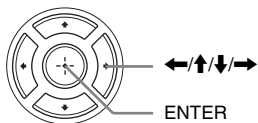

When [Easy Initial Settings] is complete, select [Easy Network Settings] to use the network functions of the player.



Playing a Disc

For playable discs, see page 38.

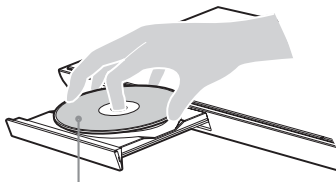
- 1 Switch the input selector on your TV so that the signal from the player appears on your TV screen.
- 2 Press \triangle OPEN/CLOSE, and place a disc on the disc tray.



Playing side facing down

- 3 Press \triangle OPEN/CLOSE to close the disc tray.
Playback starts.
If playback does not start automatically, select \bullet in the  [Video],  [Music], or  [Photo] category, and press ENTER.

Enjoying BONUSVIEW/ BD-LIVE

Some BD-ROMs with the “BD-LIVE” logo* have bonus contents and other data that can be downloaded for your enjoyment.

*BD-LIVE™

- 1 Connect a USB memory to the USB jack on the player (page 10).
Use a 1 GB or larger USB memory as your local storage.
- 2 Prepare for BD-LIVE (BD-LIVE only).
 - Connect the player to a network (page 18).
 - Set [BD Internet Connection] to [Allow] (page 30).
- 3 Insert a BD-ROM with BONUSVIEW/BD-LIVE.
The operation method differs depending on the disc. Refer to the instruction manual supplied with the disc.



To delete data in the USB memory, select [Erase BD Data] in the  [Video], and press ENTER. All data stored in the buda folder will be erased.

Enjoying Blu-ray 3D

You can enjoy a Blu-ray 3D Disc with the “Blu-ray 3D” logo*.



1 Prepare for Blu-ray 3D Disc playback.

- Connect the player to your 3D-compatible devices using a High Speed HDMI Cable.
- Set [3D Output Setting] and [TV Screen Size Setting for 3D] in the [Screen Settings] setup (page 28).

2 Insert a Blu-ray 3D Disc.

The operation method differs depending on the disc. Refer to the instruction manual supplied with the disc.



Refer also to the instruction manuals supplied with your TV and the connected device.

Displaying the play information

You can view the playback information, etc., by pressing DISPLAY. The displayed information differs depending on the disc type and player status.

Example: when playing a BD-ROM

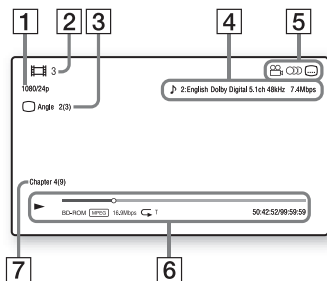





- 1 Output resolution/Video frequency
- 2 Title number or name
- 3 The currently selected angle
- 4 The currently selected audio setting
- 5 Available functions (angle, audio, subtitle)
- 6 Playback information
Displays the Play mode, Playing status bar, Disc type, Video codec, Bitrate, Repeat type, Elapsed time, and Total playing time.
- 7 Chapter number

Playing from a USB Device

For “Playable types of files”, see page 39.

- 1 **Connect the USB device to the USB jack on the player (page 10).**
Refer to the instruction manual supplied with the USB device before connecting.

2 Select  [Video],  [Music], or  [Photo] on the home menu using  .

3 Select  [USB device] using  , and press ENTER.





Playing via a Network

Enjoying Sony Entertainment Network

Sony Entertainment Network serves as a gateway, delivering the selected Internet content and a variety of on-demand entertainment straight to your player.



- Some Internet content requires registration via a PC before it can be played. For further details, visit the following website:
<http://www.sony.com/bluraysupport/>
- Some Internet content may not be available in some regions/countries.





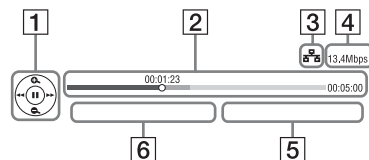

- 1** Connect the player to a network (page 18).
- 2** Press SEN button on the remote.
- 3** Select an Internet content and a variety of on-demand entertainment using    , and press ENTER.

Video streaming control panel

The control panel appears when the video file starts playing. The displayed items may differ depending on Internet content providers.

To display again, press DISPLAY.



- 1** Control display
Press     or ENTER for playback operations.
- 2** Playing status bar
Status bar, Cursor indicating the current position, Playing time, Duration of the video file
- 3** Network condition
 indicates the signal strength for wireless connection.
 indicates the wired connection.
- 4** Network transmission speed
- 5** The file name of the next video
- 6** The file name of the current video selection

Playing files on a Home Network (DLNA)

A DLNA-compatible product can play video/music/photo files stored on another DLNA-compatible product via a network.

- 1** Prepare to use DLNA.
 - Connect the player to a network (page 18).
 - Prepare the other necessary DLNA-compatible products. Refer to the instruction manual supplied with the product.

To play a file from a DLNA server via this unit (DLNA player)

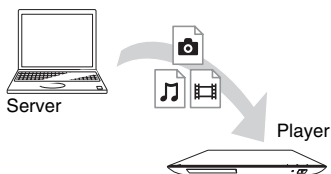

Select the DLNA server icon from [Video], [Music], or [Photo], then choose the file you want to play.

To play a file from a DLNA server via another product (Renderer)

When you play files from a DLNA Server on this unit, you can use a DLNA Controller-compatible product (a phone, etc.), to control playback.

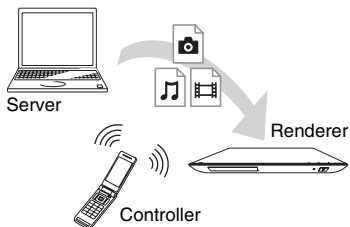

Control this unit using a DLNA controller. Refer to the instruction manual supplied with the DLNA controller.

Playing the same music in different rooms (PARTY STREAMING)

You can play music files on the player (PARTY host) in other rooms simultaneously through Sony products (PARTY guest) which are compatible with DLNA and the PARTY STREAMING function, or vice versa.

1 Prepare for PARTY STREAMING.

- Connect the player to a network (page 18).
- Connect the products which are compatible with the PARTY STREAMING function to a network.

To use the player as PARTY host

Select a track in [Music], then select [Start PARTY] from the options menu to start a PARTY.

To use the player as PARTY guest

Select [PARTY] in [Music], then select the PARTY host product icon.



The sale and product lineup of products that are compatible with the PARTY STREAMING function differ depending on the area.

Available Options

Various settings and playback operations are available by pressing **OPTIONS**. The available items differ depending on the situation.

Common options

- **[Repeat Setting]:** Sets the repeat mode.
- **[3D Menu]:**
 - [Simulated 3D]: Adjusts the simulated 3D effect.
 - [3D Depth Adjustment]: Adjusts the depth of 3D image.
 - [2D Playback]: Sets playback to 2D image.
- **[Play]/[Stop]:** Starts or stops the playback.
- **[Play from beginning]:** Plays the item from the beginning.

[Video] only

- **[3D Output Setting]:** Sets whether or not to output 3D video automatically.
- **[A/V SYNC]:** Adjusts the gap between picture and sound, by delaying the sound output in relation to the picture output (0 to 120 milliseconds).
- **[Video Settings]:**
 - [Picture Quality Mode]: Selects the picture settings for different lighting environments.
 - [BNR]: Reduces the mosaic-like block noise in the picture.
 - [MNR]: Reduces minor noise around the picture outlines (mosquito noise).
- **[Pause]:** Pauses the playback.
- **[Top Menu]:** Displays the BD's or DVD's Top Menu.
- **[Menu]/[Pop-up Menu]:** Displays the BD-ROM's Pop-up Menu or DVD's menu.

- **[Title Search]:** Searches for a title on BD-ROMs/DVD VIDEOS and starts playback from the beginning.
- **[Chapter Search]:** Searches for a chapter and starts playback from the beginning.
- **[Audio]:** Switches the language track when multilingual tracks are recorded on BD-ROMs/DVD VIDEOS. Selects the sound track on CDs.
- **[Subtitle]:** Switches the subtitle language when multilingual subtitles are recorded on BD-ROMs/DVD VIDEOS.
- **[Angle]:** Switches to other viewing angles when multi-angles are recorded on BD-ROMs/DVD VIDEOS.
- **[IP Content Noise Reduction]:** Adjusts the picture quality of Internet contents.
- **[Video Search]:** Displays information on the BD-ROM/DVD-ROM based on Gracenote technology. Searches for related information using keywords from Gracenote when selecting [Cast] or [Related]. Displays a list of titles when selecting [Playback History] or [Search History].

[Music] only

- **[Add Slideshow BGM]:** Registers music files in the USB memory as slideshow background music (BGM).
- **[Start PARTY]:** Starts a PARTY with the selected source. This item may not appear depending on the source.
- **[Leave PARTY]:** Leaves from a PARTY which the player is participating in. The PARTY STREAMING function continues among other participating products.

- **[Close PARTY]:** Closes a PARTY which the player is participating in. The PARTY STREAMING function ends for all other participating products.
- **[Music Search]:** Displays information on the audio CD (CD-DA) based on Gracenote technology. Searches for related information using keywords from Gracenote when selecting [Track], [Artist] or [Related].
Displays a list of titles when selecting [Playback History] or [Search History].

[Photo] only

- **[Slideshow Speed]:** Changes the slideshow speed.
- **[Slideshow Effect]:** Sets the effect for slideshows.
- **[Slideshow BGM]:**
 - [Off]: Turns off the function.
 - [My Music from USB]: Sets the music files registered in [Add Slideshow BGM].
 - [Play from Music CD]: Sets the tracks in CD-DAs.
- **[Change Display]:** Switches between [Grid View] and [List View].
- **[Slideshow]:** Plays a slideshow.
- **[Rotate Left]:** Rotates the photo counterclockwise by 90 degrees.
- **[Rotate Right]:** Rotates the photo clockwise by 90 degrees.

Browsing Websites

You can connect to the Internet and enjoy websites.

1 Prepare the Internet Browser.

Connect the player to a network (page 18).

2 Select [Network] on the home menu using \leftarrow/\rightarrow .

3 Select [Internet Browser] using \uparrow/\downarrow , and press ENTER.



This browser does not support some websites functions, and some websites may not be shown correctly.

To enter a URL

Select [URL entry] from the options menu. Enter the URL using the software keyboard, then select [Enter].

To set the default start page

While displaying the page you want to set, select [Set as start page] from the options menu.

To return to the previous page

Select [Previous page] from the options menu.

When the previous page does not appear even if you select [Previous page], select [Window List] from the options menu and select the page you want to return to from the list.

To quit the Internet browser

Press HOME.

Internet browser display

You can check the website information by pressing DISPLAY.

The display information differs depending on the website and page status.

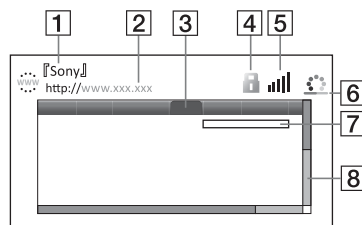

- 1 Page title
- 2 Page address
- 3 Cursor
Move by pressing $\leftarrow/\uparrow/\downarrow/\rightarrow$.
Place the cursor on the link you want to view, then press ENTER. The linked website is displayed.
- 4 SSL icon
Displays when the website is protected and connected safely.
- 5 Signal strength indicator (wireless network connection only)
- 6 Progress bar/Loading icon
Appears when the page is being read, or during file download/transfer.
- 7 Text input field
Press ENTER and select [Input] from the options menu to display the software keyboard.
- 8 Scroll bar
Press $\leftarrow/\uparrow/\downarrow/\rightarrow$ to move the page display left, up, down or right.

Available options

Various settings and operations are available by pressing **OPTIONS**. The available items differ depending on the situation.

- **[Browser Setup]:** Displays the Internet Browser settings.
 - [Zoom]: Increases or decreases the size of the displayed contents.
 - [JavaScript Setup]: Enables or disables JavaScript.
 - [Cookie Setup]: Sets whether or not to accept cookies.
 - [SSL Alarm Display]: Enables or disables SSL.
- **[Input]:** Displays the software keyboard to enter characters while browsing a website.
- **[Break]:** Moves the cursor to the next line in the text input field.
- **[Delete]:** Erases one character on the left side of the cursor during text input.
- **[Window List]:** Displays a list of currently opened website windows. Allows you to return to a previously displayed website by selecting the window.
- **[Bookmark List]:** Displays the bookmark list.
- **[URL entry]:** Allows you to enter a URL when the software keyboard is displayed.
- **[Previous page]/[Next page]:** Moves to the previous/next page.
- **[Cancel loading]:** Stops loading a page.
- **[Reload]:** Reloads the same page.
- **[Add to Bookmark]:** Adds the currently displayed website to the bookmark list.
- **[Set as start page]:** Sets the currently displayed website as the default start page.
- **[Open in new window]:** Opens a link in a new window.
- **[Character encoding]:** Sets the character code.
- **[Display certificate]:** View server certificates sent from pages that support SSL.

Settings and Adjustments

Using the Settings Displays

Select  [Setup] on the home menu when you need to change the settings of the player.

The default settings are underlined.

1 Select  [Setup] on the home menu using **←/→**.

2 Select the setup category icon using **↑/↓**, and press **ENTER**.

[Network Update]

Select [OK] to update the player's software via the network.



- We recommend performing the network update every 2 months or so.
- For information about update functions, visit the following website:
<http://www.sony.com/bluraysupport/>

[Screen Settings]

■ [3D Output Setting]

[Auto]: Normally select this.

[Off]: Select this to display all content in 2D.

■ [TV Screen Size Setting for 3D]

Sets the screen size of your 3D-compatible TV.

■ [TV Type]

[16:9]: Select this when connecting to a wide-screen TV or a TV with a wide mode function.

[4:3]: Select this when connecting to a 4:3 screen TV without a wide mode function.

■ [Screen Format]

[Full]: Select this when connecting to a TV with a wide mode function. Displays a 4:3 screen picture in 16:9 aspect ratio even on a wide-screen TV.

[Normal]: Changes the picture size to fit the screen size with the original picture aspect ratio.

■ [DVD Aspect Ratio]

[Letter Box]: Displays a wide picture with black bands on the top and bottom.



[Pan & Scan]: Displays a full-height picture on the entire screen, with trimmed sides.



■ [Cinema Conversion Mode]

[Auto]: Normally select this. The player automatically detects whether the material is video-based or film-based, and switches to the appropriate conversion method.

[Video]: The conversion method suited for video-based material will always be selected regardless of the material.

■ [Output Video Format]

[HDMI]: Normally select [Auto]. Select [Original Resolution] to output the resolution recorded on the disc. When the resolution is lower than the SD resolution, it is scaled up to the SD resolution.

[Video]: Automatically sets the lowest resolution.

■ [BD-ROM 24p Output]

[Auto]: Outputs 1920 × 1080p/24 Hz video signals only when connecting a 1080/24p-compatible TV using the HDMI OUT jack.

[On]: Turns on the function.

[Off]: Select this when your TV is not compatible with 1080/24p video signals.

■ [DVD-ROM 24p Output]

[Auto]: Outputs 1920 × 1080p/24 Hz video signals only when connecting a 1080/24p-compatible TV using the HDMI OUT jack.

[Off]: Select this when your TV is not compatible with 1080/24p video signals.

■ [YCbCr/RGB (HDMI)]

[Auto]: Automatically detects the connected TV type, and switches to the matching color setting.

[YCbCr (4:2:2)]: Outputs YCbCr 4:2:2 video signals.

[YCbCr (4:4:4)]: Outputs YCbCr 4:4:4 video signals.

[RGB]: Outputs RGB video signals.

■ [HDMI Deep Color Output]

[Auto]: Normally select this.

[16bit]/[12bit]/[10bit]: Outputs 16bit/12bit/10bit video signals when the connected TV is compatible with Deep Color.

[Off]: Select this when the picture is unstable or colors appear unnatural.

■ [Pause Mode]

[Auto]: Normally select this. Dynamic moving pictures appear without blurring.

[Frame]: Displays static pictures at high resolution.

**[Audio Settings]**

■ [Audio (HDMI)]

[Auto]: Normally select this. Outputs audio signals according to the status of the connected HDMI device.

[PCM]: Outputs PCM signals from the HDMI OUT jack.

■ [DSD Output Mode]

[On]: Outputs DSD signals from the HDMI OUT jack when playing a Super Audio CD. When [On] is selected, no signal is output from other jacks.

[Off]: Outputs PCM signals from the HDMI OUT jack when playing a Super Audio CD.

■ [BD Audio MIX Setting]

[On]: Outputs the audio obtained by mixing the interactive and secondary audio to the primary audio.

[Off]: Outputs the primary audio only. Select this to output HD audio signals to an AV amplifier (receiver).

■ [Dolby Digital / DTS]

[Downmix PCM]: Converts to output Linear PCM signals. Select this when connecting an audio device without a built-in Dolby Digital or DTS decoder.
[Bitstream]: Select this when connecting an audio device with a built-in Dolby Digital or DTS decoder.

■ [DTS Neo:6]

[Cinema]/[Music]: Outputs the simulated multi-channel sound from 2 channel sources via the HDMI OUT jack according to the capability of the connected device using DTS Neo:6 Cinema or DTS Neo:6 Music mode.
[Off]: Outputs the sound with its original number of channels via the HDMI OUT jack.

■ [Audio DRC]

[Auto]: Performs playback at the dynamic range specified by the disc (BD-ROM only). Other discs are played back at the [On] level.
[On]: Performs playback at a standard compression level.
[Off]: No compression works. A more dynamic sound is produced.

■ [Downmix]

[Surround]: Outputs audio signals with surround effects. Select this when connecting an audio device that supports Dolby Surround (Pro Logic) or DTS Neo:6.
[Stereo]: Outputs audio signals without surround effects. Select this when connecting an audio device that does not support Dolby Surround (Pro Logic) or DTS Neo:6.

[BD/DVD Viewing Settings]

■ [BD/DVD Menu Language]

Selects the default menu language for BD-ROMs or DVD VIDEOS. Select [Select Language Code], and enter the code for your language, referring to “Language code list” (page 42).

■ [Audio Language]

Selects the default track language for BD-ROMs or DVD VIDEOS. When you select [Original], the language given priority in the disc is selected. Select [Select Language Code], and enter the code for your language, referring to “Language code list” (page 42).

■ [Subtitle Language]

Selects the default subtitle language for BD-ROMs or DVD VIDEOS. Select [Select Language Code], and enter the code for your language, referring to “Language code list” (page 42).

■ [BD Hybrid Disc Playback Layer]

[BD]: Plays BD layer.
[DVD/CD]: Plays DVD or CD layer.

■ [BD Internet Connection]

[Allow]: Normally select this.
[Do not allow]: Prohibits Internet connection.

[Parental Control Settings]

■ [Password]

Sets or changes the password for the Parental Control function. A password allows you to set a restriction on BD-ROM or DVD VIDEO, and Internet video playback. If necessary, you can differentiate the restriction levels for BD-ROMs, DVD VIDEOS, and Internet videos.

■ [Parental Control Area Code]

Playback of some BD-ROMs, DVD VIDEOS, or Internet videos can be limited according to the geographic area. Scenes may be blocked or replaced with different scenes. Follow the on-screen instructions and enter your four-digit password.

■ [BD Parental Control] / [DVD Parental Control] / [Internet Video Parental Control]

By setting Parental Control, scenes can be blocked or replaced with different scenes. Follow the on-screen instructions and enter your four-digit password.

■ [Internet Video Unrated]

[Allow]: Allows the playback of unrated Internet videos.

[Block]: Blocks the playback of unrated Internet videos.

[Music Settings]

■ [Super Audio CD Playback Layer]

[Super Audio CD]: Plays the Super Audio CD layer.

[CD]: Plays the CD layer.

■ [Super Audio CD Playback Channel]

[DSD 2ch]: Plays the 2ch area.

[DSD Multi]: Plays the multi-channel area.

[System Settings]

■ [OSD Language]

Selects on-screen display language for your player.

■ [Dimmer]

[Bright]: Bright lighting.

[Dark]: Low lighting.

[Off]: Turns off the lighting during playback. Low lighting other than during playback.

■ [Control for HDMI]

[On]: The following BRAVIA Sync features are available:

- One-Touch Play
 - System Power-Off
 - Language Follow
- [Off]: Turns off the function.



For details, refer to the instruction manual supplied with the TV or components.

■ [HDMI: Linked to TV-off]

[On]: Automatically turns off the player and HDMI-compatible components when the connected TV enters standby mode (BRAVIA Sync).

[Off]: Turns off the function.

■ [Quick Start Mode]

[On]: Shortens the startup time when turning on the player.

[Off]: Reduces standby power consumption.

■ [Auto Display]

[On]: Automatically displays information on the screen when changing the viewing titles, picture modes, audio signals, etc.

[Off]: Displays information only when you press DISPLAY.

■ [Screen Saver]

[On]: Turns on the screen saver function. The screen saver image appears when you do not use the player for more than 10 minutes while an on-screen display is displayed.

[Off]: Turns off the function.

■ [Software Update Notification]

[On]: Sets the player to inform you of newer software version information (page 28).

[Off]: Turns off the function.

■ [Gracenote Settings]

[Auto]: Automatically downloads disc information when disc playback stops. Connect to the network for downloading.

[Manual]: Downloads the disc information when [Video Search] or [Music Search] is selected.

■ [System Information]

Displays the player's software version information and the MAC address.

■ [Software License Information]

Displays information about the Software License.



[Network Settings]

■ [Internet Settings]

Connect the player to the network beforehand. For details, see “Step 3: Preparing for Network Connection” (page 18).

[Wired Setup]: Select this when you connect to a broadband router using a LAN cable.

[Wireless Setup(built-in)]: Select this when you use the wireless LAN that is built into the player for wireless network connection.

[View Network Status]: Displays the current network status.



For further details, visit the following website and check the FAQ contents:
<http://www.sony.com/bluraysupport/>

■ [Network Connection Diagnostics]

Checks for the proper network connection by running the network diagnostics.

■ [Connection Server Settings]

Sets whether or not to display the connected server.

■ [Renderer Options]

[Auto Access Permission]: Sets whether or not to allow automatic access from newly detected DLNA controller-compatible product.

[Renderer Name]: Displays the player's name as it is listed on other DLNA products on the network.

■ [Renderer Access Control]

Displays a list of DLNA controller-compatible products and sets whether or not each product is accessible via this player.

■ [PARTY Auto Start]

[On]: Starts a PARTY or joins an existing PARTY at the request of a networked product compatible with the PARTY STREAMING function.
[Off]: Turns off the function.

■ [Media Remote Device Registration]

Registers your "Media Remote" device.

■ [Registered Media Remote Devices]

Displays a list of your registered "Media Remote" devices.

■ [Remote Start]

[On]: Turns on or off the player using your "Media Remote" when connecting to the network.

[Off]: Turns off the functions.

 **[Easy Setup]**
1-2-3

■ [Easy Initial Settings]

Select [Easy Initial Settings] to specify the basic settings. Follow the on-screen instructions.

■ [Easy Network Settings]

Select [Easy Network Settings] to specify the network settings. Follow the on-screen instructions.

 **[Resetting]**

■ [Reset to Factory Default Settings]

You can reset the player settings to the factory default by selecting the group of settings. All the settings within the group will be reset.

■ [Initialize Personal Information]

You can erase your personal information stored in the player.

Additional Information

Troubleshooting

If you experience any of the following difficulties while using the player, use this troubleshooting guide to help remedy the problem before requesting repairs. Should any problem persist, consult your nearest Sony dealer.

Picture

There is no picture or the picture is not output correctly.

- ➔ Check that all the connecting cables are securely connected (page 15).
- ➔ Switch the input selector on your TV to display the signal from the player.
- ➔ Reset the video output resolution to the lowest resolution by pressing ■ on the player for more than 10 seconds.
- ➔ For HDMI connections, try the following: ①Turn the player off and on again. ②Turn the connected equipment off and on again. ③Disconnect and then reconnect the HDMI cable.
- ➔ The HDMI OUT jack is connected to a DVI device that does not support copyright protection technology.
- ➔ For HDMI connections, check the [Output Video Format] settings in the [Screen Settings] setup (page 29).
- ➔ When the analog signals are also output, set [BD-ROM 24p Output] or [DVD-ROM 24p Output] to [Off] in the [Screen Settings] setup (page 29).
- ➔ For BD-ROMs, check the [BD-ROM 24p Output] or [DVD-ROM 24p

Output] setting in the [Screen Settings] setup (page 29).

The display language on the screen switches automatically when connected to the HDMI OUT jack.

- ➔ When [Control for HDMI] is set to [On] (page 31), the display language on the screen automatically switches according to the language setting of the connected TV (if you change the setting on your TV, etc.).

Sound

There is no sound or the sound is not output correctly.

- ➔ Check that all the connecting cables are securely connected (page 15).
- ➔ Switch the input selector on your AV amplifier (receiver) so that the audio signals of the player are output from your AV amplifier (receiver).
- ➔ If the audio signal does not come through the DIGITAL OUT (OPTICAL/COAXIAL)/HDMI OUT jack, check the audio settings (page 29).
- ➔ For HDMI connections, try the following: ①Turn the player off and on again. ②Turn the connected equipment off and on again. ③Disconnect and then reconnect the HDMI cable.
- ➔ For HDMI connections, if the player is connected to a TV through an AV amplifier (receiver), try connecting the HDMI cable directly to the TV. Refer also to the instruction manual supplied with the AV amplifier (receiver).
- ➔ The HDMI OUT jack is connected to a DVI device (DVI jacks do not accept audio signals).

- ➔ The device connected to the HDMI OUT jack does not support the audio format of the player. Check the audio settings (page 29).

The HD Audio (Dolby Digital Plus, Dolby TrueHD, DTS-HD High Resolution Audio, and DTS-HD Master Audio) is not output by bitstream.

- ➔ Set [BD Audio MIX Setting] to [Off] in the [Audio Settings] setup (page 29).
- ➔ Check that the connected AV amplifier (receiver) is compatible with each HD Audio format.

The interactive audio is not output.

- ➔ Set [BD Audio MIX Setting] to [On] in the [Audio Settings] setup (page 29).

Disc

The disc does not play.

- ➔ The disc is dirty or skewed.
- ➔ The disc is upside down. Insert the disc with the playback side facing down.
- ➔ The disc has a format that cannot be played back by this player (page 38).
- ➔ The player cannot play a recorded disc that is not correctly finalized.
- ➔ The region code on the BD or DVD does not match the player.

USB device

The player does not detect a USB device connected to the player.

- ➔ Make sure that the USB device is securely connected to the USB jack.
- ➔ Check if the USB device or a cable is damaged.

- ➔ Check if the USB device is on.
- ➔ If the USB device is connected via a USB hub, connect the USB device directly to the player.

Sony Entertainment Network

The picture/sound is poor/certain programs display a loss of detail, especially during fast-motion or dark scenes.

- ➔ Picture/sound quality may be improved by changing the connection speed. Recommended connection speed is of at least 2.5 Mbps for standard definition video (10 Mbps for high definition video).

The picture is small.

- ➔ Press **↑** to zoom in.

Network connection

The player cannot connect to the network.

- ➔ Check the network connection (page 18) and the network settings (page 32).

You cannot connect your PC to the Internet after [Wi-Fi Protected Setup (WPS)] is performed.

- ➔ The wireless settings of the router may change automatically if you use the Wi-Fi Protected Setup function before adjusting the settings of the router. In this case, change the wireless settings of your PC accordingly.

You cannot connect the player to the wireless LAN router.

- ➔ Check if the wireless LAN router is on.
- ➔ Depending on the surrounding environment, such as the wall material, radio wave receiving condition, or obstacles between the player and the wireless LAN router, the communication distance may be shortened. Move the player and the wireless LAN router closer to each other.
- ➔ Devices that use a 2.4 GHz frequency band, such as a microwave, Bluetooth, or digital cordless device, may interrupt the communication. Move the player away from such devices, or turn off such devices.

The desired wireless router do not appear in the wireless network list.

- ➔ Press RETURN to return to the previous screen, and try wireless setup again. If the desired wireless router is still not detected, press RETURN to select [Manual registration].

The message [A new software version is available. Please go to the "Setup" section of the menu and select "Network update" to perform the update.] appears on the screen when turning the player on.

- ➔ See [Network Update] (page 28) to update the player to a newer software version.

You cannot start the PARTY STREAMING function.

- ➔ Check that [PARTY Auto Start] is set to [On] in [Network Settings] (page 33).

Control for HDMI (BRAVIA Sync)

The [Control for HDMI] function does not work (BRAVIA Sync).

- ➔ Check that [Control for HDMI] is set to [On] (page 31).
- ➔ If you change the HDMI connection, turn the player off and on again.
- ➔ If power failure occurs, set [Control for HDMI] to [Off], then set [Control for HDMI] to [On] (page 31).
- ➔ Check the following and refer to the instruction manual supplied with the component.
 - the connected component is compatible with the [Control for HDMI] function.
 - the connected component's setting for the [Control for HDMI] function is correct.
- ➔ When you connect the player to a TV through an AV amplifier (receiver),
 - if the AV amplifier (receiver) is not compatible with the [Control for HDMI] function, you may be unable to control the TV from the player.
 - if you change the HDMI connection, disconnect and reconnect the AC power cord, or a power failure occurs, try the following:
 - ① Switch the input selector of the AV amplifier (receiver) so that the picture from the player appears on the TV screen.
 - ② Set [Control for HDMI] to [Off], then set [Control for HDMI] to [On] (page 31). Refer to the instruction manual supplied with the AV amplifier (receiver).

The System Power-Off function does not work (BRAVIA Sync).

- ➔ Check that [Control for HDMI] and [HDMI: Linked to TV-off] are set to [On] (page 31).

Others

Playback does not start from the beginning of content.

- ➔ Press **OPTIONS**, and select [Play from beginning].

Playback does not start from the resume point where you last stopped playing.

- ➔ The resume point may be cleared from memory depending on the disc when
 - you open the disc tray.
 - you disconnect the USB device.
 - you play other content.
 - you turn off the player.

The disc tray does not open and “LOCK” or “D ON” appears on the front panel display.

- ➔ When “LOCK” appears, the player is locked. To cancel the Child Lock, hold down **▶** on the player until “UNLCK” appears on the front panel display (page 10).
- ➔ When “D ON” appears, contact your Sony dealer or local authorized Sony service facility.

The disc tray does not open and you cannot remove the disc even after you press **▲**.

- ➔ Try the following: ① Turn the player off, and disconnect the AC power cord. ② Reconnect the AC power cord while pressing down **▲** on the player. ③ Keep pressing down **▲** on the player until the tray opens. ④ Remove the disc. ⑤ When “OPEN” appears on the front panel display, hold down **I/⏻** on the player for more than 10 seconds until the player turns off.

“Exxxx” or “TEMP” appears on the front panel display.

- ➔ When “Exxxx” appears, contact your nearest Sony dealer or local authorized Sony service facility and give the error code.
- ➔ When “TEMP” appears, place the player in a location with adequate ventilation to prevent heat build-up in the player. “TEMP” will appear for a short time.

The player does not respond to any button.

- ➔ Moisture has condensed inside the player (page 4).
- ➔ Hold down **I/⏻** on the player for more than 10 seconds until the player turns off. If the player still does not respond to any button, disconnect then reconnect the AC power cord.

Specifications

System

Laser: Semiconductor laser

Inputs and outputs

(Jack name:

Jack type/Output level/Load impedance)

LINE OUT R-AUDIO-L:

Phono jack/2 Vrms/10 kilohms

DIGITAL OUT (OPTICAL):

Optical output jack/-18 dBm (wave length 660 nm)

DIGITAL OUT (COAXIAL):

Phono jack/0.5 Vp-p/75 ohms

HDMI OUT:

HDMI 19-pin standard connector

LINE OUT VIDEO:

Phono jack/1.0 Vp-p/75 ohms

LAN (100):

100BASE-TX Terminal

USB:

USB jack Type A (For connecting a USB memory, memory card reader, digital still camera, and digital video camera)

Wireless

Wireless LAN standard:

IEEE 802.11 b/g/n

Frequency range:

2.4 GHz band: Channels 1-11

Modulation:

DSSS and OFDM

General

Power requirements: 120 V AC, 60 Hz

Power consumption: 16 W

Dimensions (approx.):

430 mm × 199 mm × 42 mm
(17 in. × 7 7/8 in. × 1 11/16 in.)
(width/depth/height)
incl. projecting parts

Mass (approx.): 1.5 kg (3 lb 5 oz)

Operating temperature:

5 °C to 35 °C (41 °F to 95 °F)

Operating humidity:

25 % to 80 %

Supplied accessories

See page 14.

Specifications and design are subject to change without notice.

Playable discs

Blu-ray Disc *1	BD-ROM BD-R *2/BD-RE *2
DVD *3	DVD-ROM DVD-R/DVD-RW DVD+R/DVD+RW
CD *3	CD-DA (Music CD) CD-ROM CD-R/CD-RW Super Audio CD

*1 Since the Blu-ray Disc specifications are new and evolving, some discs may not be playable depending on the disc type and the version.

The audio output differs depending on the source, connected output jack, and selected audio settings.

*2 BD-RE: Ver.2.1

BD-R: Ver.1.1, 1.2, 1.3 including organic pigment type BD-R (LTH type)

The BD-Rs recorded on a PC cannot be played if postscripts are recordable.

*3 A CD or DVD disc will not play if it has not been correctly finalized. For more information, refer to the instruction manual supplied with the recording device.

Discs that cannot be played

- BDs with cartridge
- BDXLs
- DVD-RAMs
- HD DVDs
- DVD Audio discs
- PHOTO CDs
- Data part of CD-Extras
- Super VCDs
- Audio material side on DualDiscs

- A disc recorded in a color system other than NTSC, such as PAL (this player conforms to the NTSC color system).

Note on Discs

This product is designed to playback discs that conform to the Compact Disc (CD) standard. DualDiscs and some of the music discs encoded with copyright protection technologies do not conform to the Compact Disc (CD) standard, therefore, these discs may not be playable by this product.

Note on playback operations of BDs/DVDs

Some playback operations of BDs/DVDs may be intentionally set by software producers. Since this player plays BDs/DVDs according to the disc contents the software producers designed, some playback features may not be available.

Note about double-layer BDs/DVDs

The playback pictures and sound may be momentarily interrupted when the layers switch.

Region code (BD-ROM/DVD VIDEO only)

Your player has a region code printed on the rear of the unit and will only play BD-ROMs/DVD VIDEOS labeled with identical region codes or .

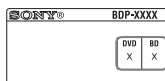

Region code

Playable types of files

Video

File format	Extensions
MPEG-1 Video/PS ^{*1*2} MPEG-2 Video/PS, TS ^{*1*3}	“.mpg,” “.mpeg,” “.m2ts,” “.mts”
MPEG-4 AVC ^{*1*2}	“.mkv,” “.mp4,” “.m4v,” “.m2ts,” “.mts”
WMV9 ^{*1*2}	“.wmv,” “.asf”
AVCHD ^{*2*4}	*5
Xvid	“.avi”

Music

File format	Extensions
MP3 (MPEG-1 Audio Layer III)	“.mp3”
AAC/HE-AAC ^{*1*2*6}	“.m4a”
WMA9 Standard ^{*1*2*6}	“.wma”
LPCM	“.wav”

Photo

File format	Extensions
JPEG	“.jpg,” “.jpeg”
PNG	“.png” ^{*7}
GIF	“.gif” ^{*7}
MPO	“.mpo” ^{*8}

- *1 The player does not play coded files such as DRM.
- *2 The player may not play this file format on a DLNA server.
- *3 The player can only play standard definition video on a DLNA server.
- *4 This player can play AVCHD Ver.2.0 format.
- *5 The player plays AVCHD format files that are recorded on a digital video camera, etc. The AVCHD format disc will not play if it has not been correctly finalized.
- *6 The player does not play coded files such as Lossless.
- *7 The player does not play animated PNG or animated GIF files.
- *8 For MPO files other than 3D, the key image or the first image is displayed.



- Some files may not play depending on the file format, file encoding, recording condition, or DLNA server condition.
- Some files edited on a PC may not play.
- The player can recognize the following files or folders in BDs, DVDs, CDs and USB devices:
 - up to folders in the 9th layer, including the root folder
 - up to 500 files/folders in a single layer
- The player can recognize the following files or folders stored in the DLNA server:
 - up to folders in the 19th layer
 - up to 999 files/folders in a single layer
- Some USB devices may not work with this player.
- The player can recognize Mass Storage Class (MSC) devices (such as flash memory or an HDD), Still Image Capture Device (SICD) class devices and 101 keyboard.
- To avoid data corruption or damage to the USB memory or devices, turn off the player when connecting or removing the USB memory or devices.
- The player may not play high bit rate video files on DATA CDs smoothly. You are recommended to play such files using DATA DVDs or DATA BDs.

About wireless LAN security

Since communication via the wireless LAN function is established by radio waves, the wireless signal may be susceptible to interception. To protect wireless communication, this player supports various security functions. Be sure to correctly configure the security settings in accordance with your network environment.

◆ No Security

Although you can easily make settings, anyone can intercept wireless communication or intrude into your wireless network, even without any sophisticated tools. Keep in mind that there is a risk of unauthorized access or interception of data.

◆ WEP

WEP applies security to communications to prevent outsiders from intercepting communications or intruding into your wireless network. WEP is a legacy security technology that enables older devices, which do not support TKIP/AES, to be connected.

◆ WPA-PSK (TKIP), WPA2-PSK (TKIP)

TKIP is a security technology developed to correct the deficiencies of WEP. TKIP assures a higher security level than WEP.

◆ WPA-PSK (AES), WPA2-PSK (AES)

AES is a security technology that uses an advanced security method that is distinct from WEP and TKIP.

AES assures a higher security level than WEP or TKIP.

Notes About the Discs

- To keep the disc clean, handle the disc by its edge. Do not touch the surface.



Dust, fingerprints, or scratches on the disc may cause it to malfunction.

- Do not expose the disc to direct sunlight or heat sources such as hot air ducts, or leave it in a car parked in direct sunlight as the temperature may rise considerably inside the car.
- After playing, store the disc in its case.
- Clean the disc with a cleaning cloth. Wipe the disc from the center out.
- Do not use solvents such as benzene, thinner, commercially available disc/lens cleaners, or anti-static spray intended for vinyl LPs.
- If you have printed the disc's label, dry the label before playing.
- Do not use the following discs.
 - A lens cleaning disc.
 - A disc that has a non-standard shape (e.g., card, heart).
 - A disc with a label or sticker on it.
 - A disc that has cellophane tape or sticker adhesive on it.
- Do not resurface the playing side of a disc to remove surface scratches.



Code numbers of controllable TVs

While holding down -TV- , enter the TV manufacturer's code using the number buttons.

If more than one code number is listed, try entering them one at a time until you find the one that works with your TV.

Manufacturer	Code number
Sony	01 (default)
Hitachi	02
LG/Goldstar	04
Mitsubishi/MGA	13
NEC	04
Panasonic	19
Philips	21
Pioneer	16
RCA	10
Samsung	20
Sharp	18
Toshiba	07

Language code list

For details, see [BD/DVD Viewing Settings] (page 30).

The language spellings conform to the ISO 639: 1988 (E/F) standard.

Code Language

1027	Afar	1028	Abkhazian
1032	Afrikaans	1039	Amharic
1044	Arabic	1045	Assamese
1051	Aymara	1052	Azerbaijani
1053	Bashkir	1057	Byelorussian
1059	Bulgarian	1060	Bihari
1061	Bislama	1066	Bengali
1067	Tibetan	1070	Breton
1079	Catalan	1093	Corsican
1097	Czech	1103	Welsh
1105	Danish	1109	German
1130	Bhutani; Dzongkha	1142	Greek
1144	English	1145	Esperanto
1149	Spanish	1150	Estonian
1151	Basque	1157	Persian
1165	Finnish	1166	Fiji
1171	Faroese	1174	French
1181	Frisian	1183	Irish
1186	Scots Gaelic	1194	Galician
1196	Guarani	1203	Gujarati
1209	Hausa	1217	Hindi
1226	Croatian	1229	Hungarian
1233	Armenian	1235	Interlingua
1239	Interlingue	1245	Inupiak
1248	Indonesian	1253	Icelandic
1254	Italian	1257	Hebrew
1261	Japanese	1269	Yiddish
1283	Javanese	1287	Georgian
1297	Kazakh	1298	Greenlandic; Kalaallisut
1299	Cambodian; Khmer	1300	Kannada
1301	Korean	1305	Kashmiri
1307	Kurdish	1311	Kirghiz
1313	Latin	1326	Lingala
1327	Laothian; Lao	1332	Lithuanian
1334	Latvian	1345	Malagasy
1347	Maori	1349	Macedonian
1350	Malayalam	1352	Mongolian
1353	Moldavian	1356	Marathi

Code Language

1357	Malay	1358	Malese; Maltese
1363	Burmese	1365	Nauru
1369	Nepali	1376	Dutch
1379	Norwegian	1393	Occitan
1403	Oromo	1408	Oriya
1417	Punjabi; Panjabi	1428	Polish
1435	Pashto; Pushto	1436	Portuguese
1463	Quechua	1481	Rhaeto- Romance
1482	Kirundi; Rundi	1483	Romanian
1489	Russian	1491	Kinyarwanda
1495	Sanskrit	1498	Sindhi
1501	Sangho; Sango	1502	Serbo- Croatian
1503	Singhalese; Sinhalese	1505	Slovak
1506	Slovenian	1507	Samoaan
1508	Shona	1509	Somali
1511	Albanian	1512	Serbian
1513	Siswati; Swati	1514	Sesotho; Sotho southern
1515	Sundanese	1516	Swedish
1517	Swahili	1521	Tamil
1525	Telugu	1527	Tajik
1528	Thai	1529	Tigrinya
1531	Turkmen	1532	Tagalog
1534	Setswana; Tswana	1535	Tonga; Tonga islands
1538	Turkish	1539	Tsonga
1540	Tatar	1543	Twi
1557	Ukrainian	1564	Urdu
1572	Uzbek	1581	Vietnamese
1587	Volapük	1613	Wolof
1632	Xhosa	1665	Yoruba
1684	Chinese	1697	Zulu
1703	Not specified		

Parental control/area code

For details, see [Parental Control Area Code] (page 31).

Code Area			
2044	Argentina	2047	Australia
2046	Austria	2057	Belgium
2070	Brazil	2090	Chile
2092	China	2093	Colombia
2115	Denmark	2165	Finland
2174	France	2109	Germany
2200	Greece	2219	Hong Kong
2248	India	2238	Indonesia
2239	Ireland	2254	Italy
2276	Japan	2304	Korea
2333	Luxembourg	2363	Malaysia
2362	Mexico	2376	Netherlands
2390	New Zealand	2379	Norway
2427	Pakistan	2424	Philippines
2428	Poland	2436	Portugal
2489	Russia	2501	Singapore
2149	Spain	2499	Sweden
2086	Switzerland	2543	Taiwan
2528	Thailand	2184	United Kingdom

The software of this player may be updated in the future. For information about any available updates and the latest Operating Instructions, please visit the following website:

<http://www.sony.com/bluraysupport/>



<http://www.sony.net/>

Printed on 70% or more recycled paper using VOC (Volatile Organic Compound)-free vegetable oil based ink.

4-410-140-11(1)



© 2012 Sony Corporation
Printed in Malaysia